

2

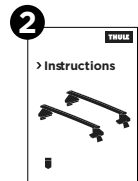

> Instructions

Thule Evo Clamp
7105

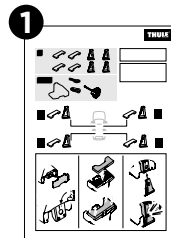
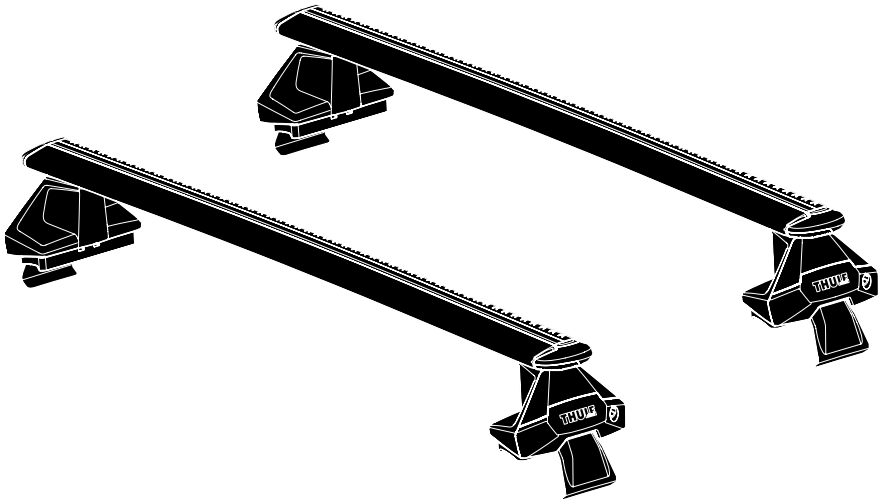

EN Roof mounted load carrier
DE Lastenträger zur Dachmontage
FR Barre de toit
NL Dakdrager
IT Barra portatutto da installare sul tetto
ES Portaequipajes de techo
PT Barra para montagem no tejadilho
SV Takmonterad lasthållare
DK Tagmonteret lastholder
NO Takmontert lasteholder
FI Katolle asennettava teline
ET Katusele paigaldatav katuseraam
LV Uz jumta uzstādāms kravas turētājs
LT Ant stogo tvirtinamas krovinijų laikiklis
PL Uchwyt na bagażnik bazowy montowany na dachu
RU Багажник на крышу
UK Багажник для даху
BG Багажник, монтиран върху покрива
CS Nosič pro montáž na střechu
SK Strešný nosič
SL Nosilec za strešni prtljažnik

HR/BIH Krovni nosač tereta
RO Suport încărcătură montat pe acoperiș
HU Tetőre szerelhető csomagszállító
EL Σχάρα οροφής για μεταφορά φορτίου
TR Araç üstüne bağlanan yük taşıyıcı

HE מנשא מטען לגג הרכב
AR حامل نقل مثبت على السقف

ZH 顶置行李架
JA ルーフマウント型ロードキャリア
KO 루프 장착 화물 캐리어
TH โครยัดของบรรทุกแบบติดตั้งบนหลังคา

CITY CRASH

Complies with ISO norm

ISO 11154-E

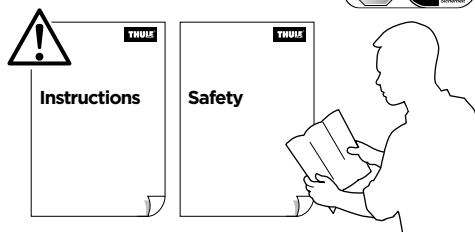

> Mounting Tutorial

Thule Evo Clamp

THULE
SWEDEN

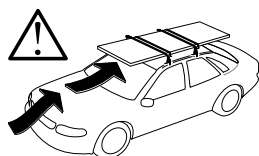

80 km/h
50 Mph

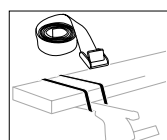
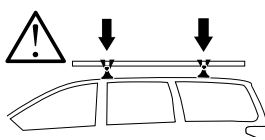
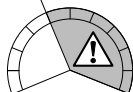

1
KIT

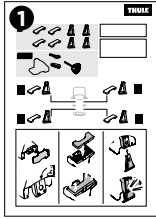

2
FOOT PACK

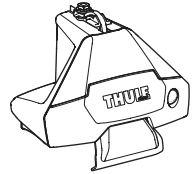
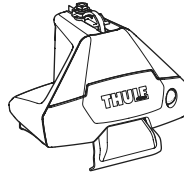
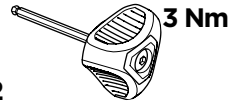
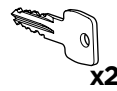
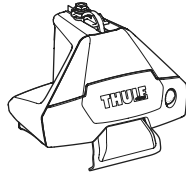
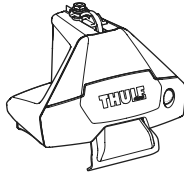
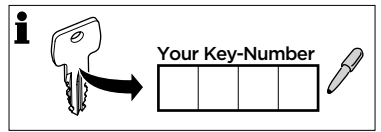
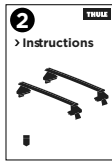

3
BAR



THULE
WingBar Evo

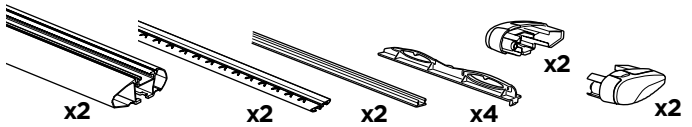

THULE
WingBar

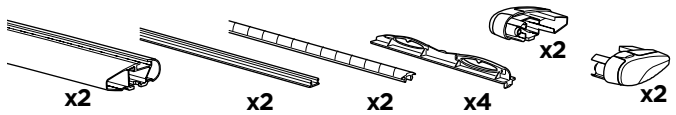

THULE
SlideBar

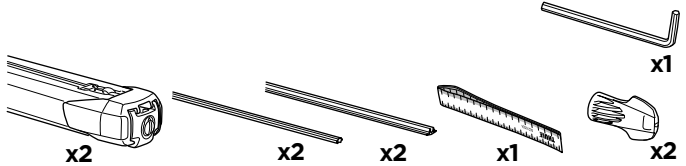

THULE
ProBar

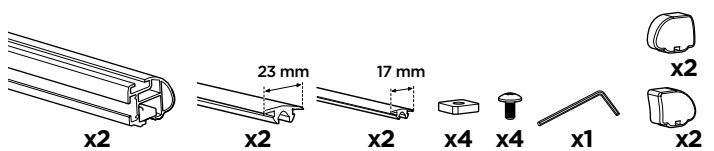

THULE
SquareBar

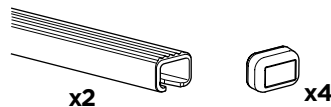

4

BAR

3

THULE
WingBar Evo

A

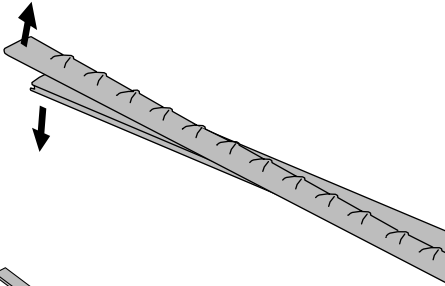

B

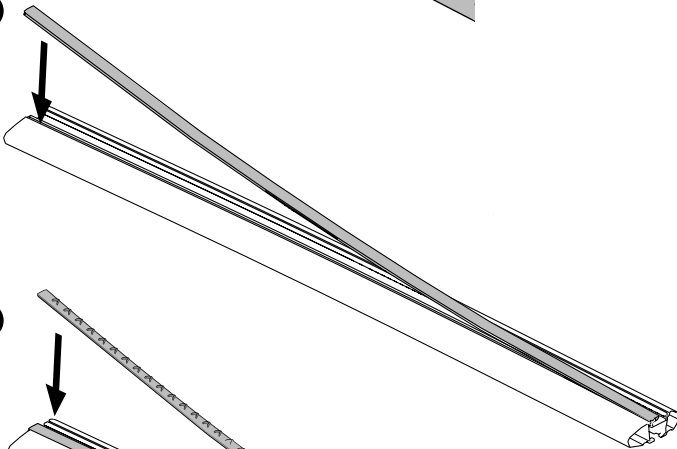

C

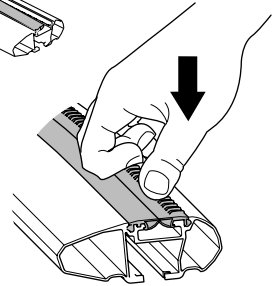
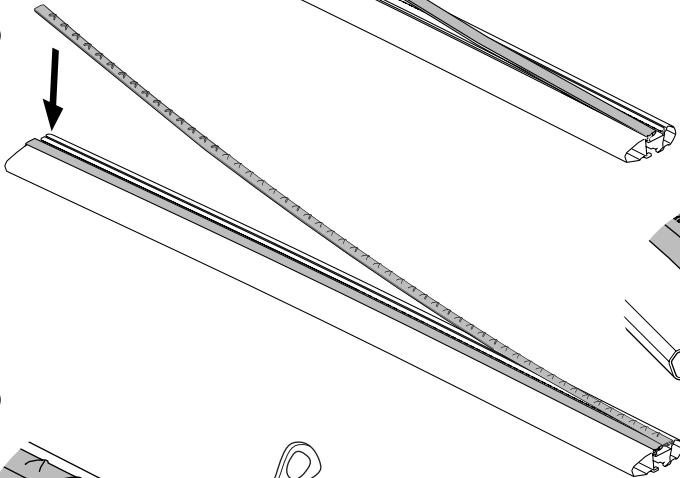

D

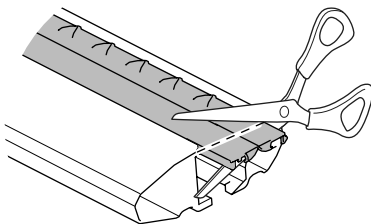

x2

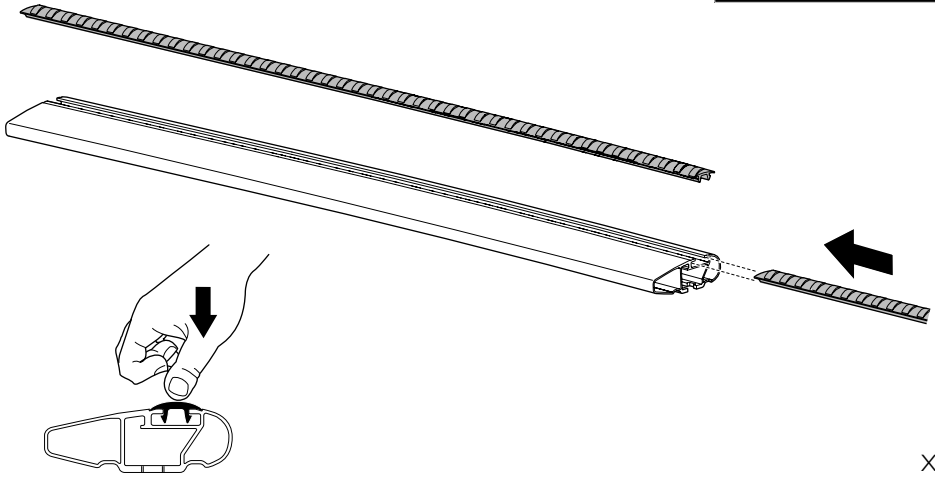

5



A

B

C

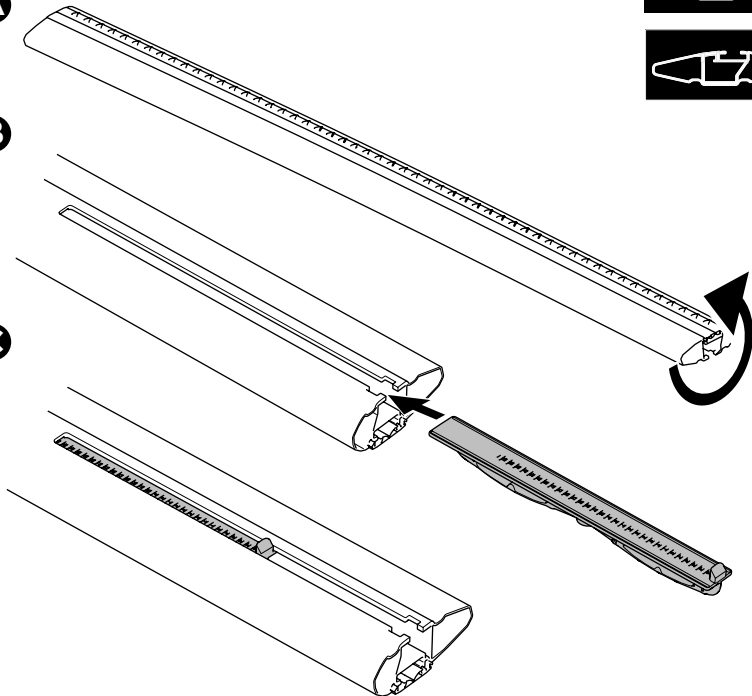

6



+



+

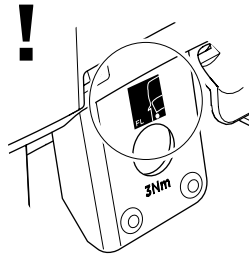
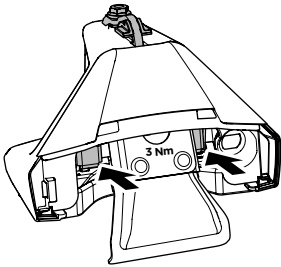

A

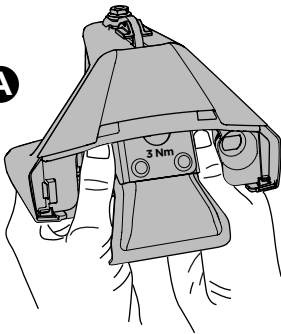

B

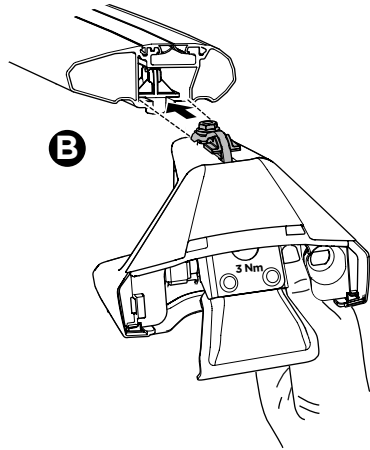

x4

7

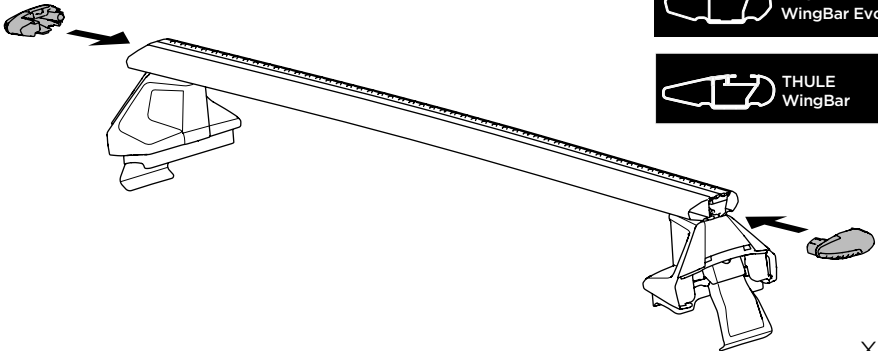

x2

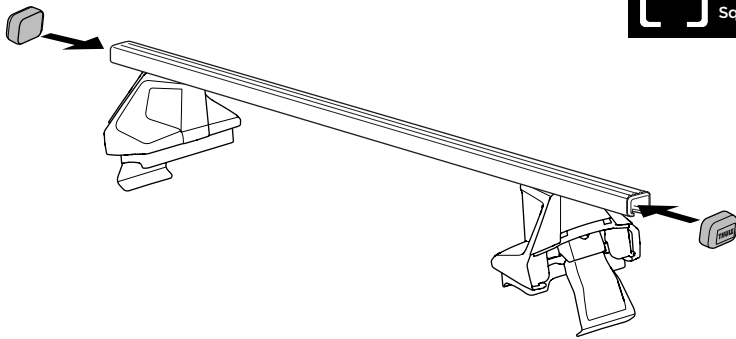

THULE
SquareBar

x2

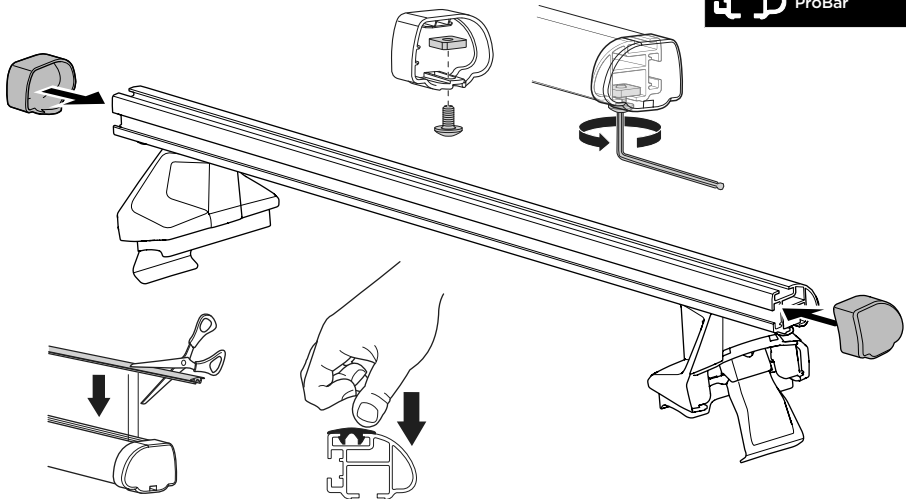

THULE
ProBar

x2

THULE
SlideBar

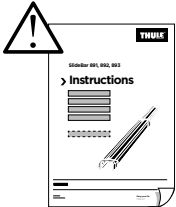
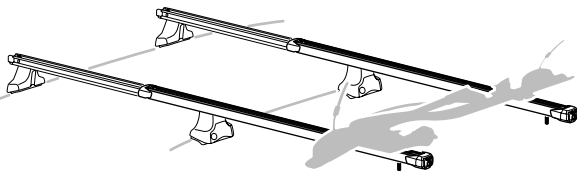

8

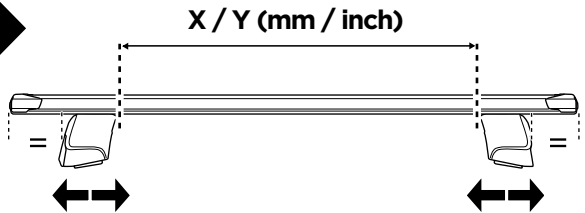
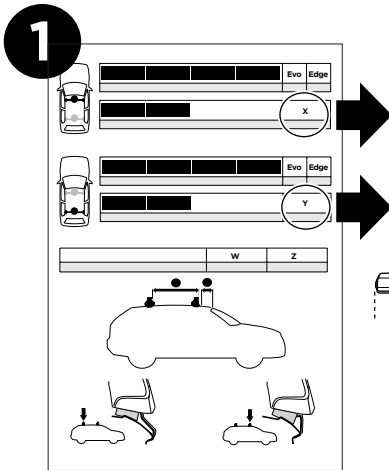
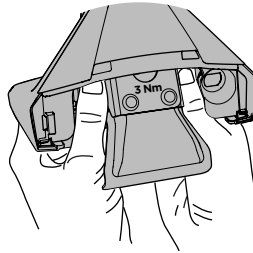
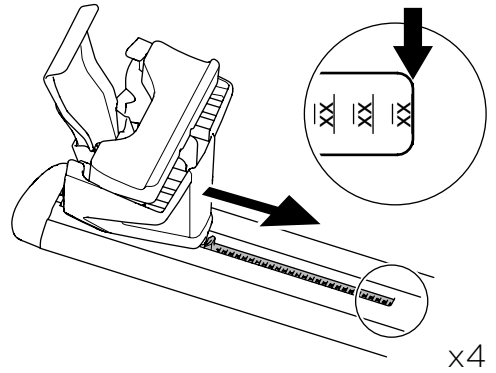
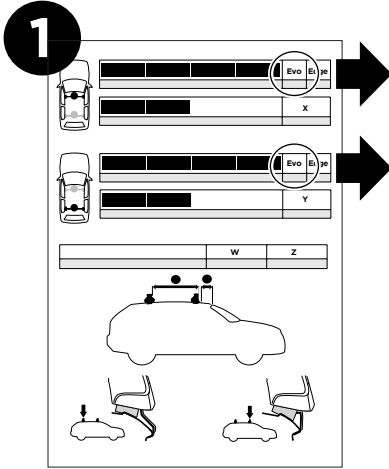
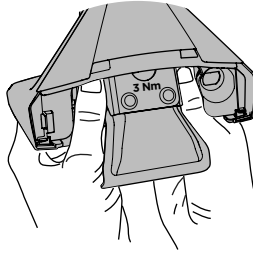

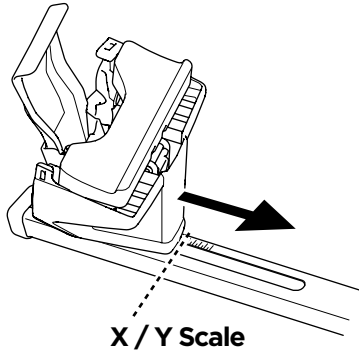
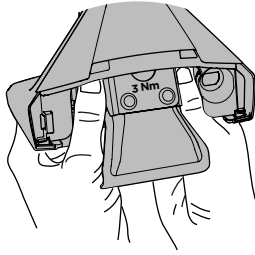
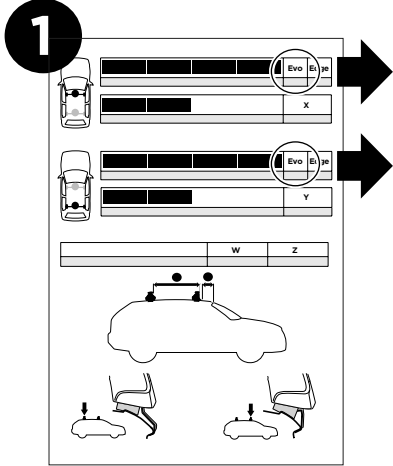

x4

9

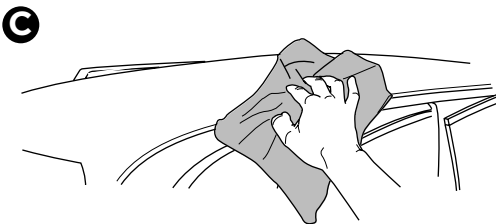
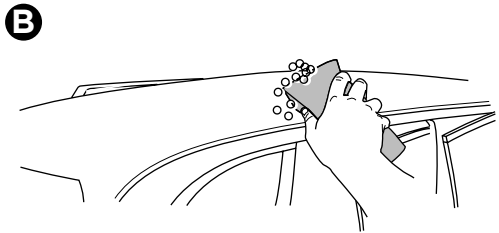
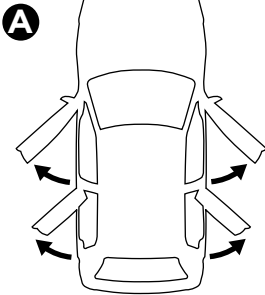

10

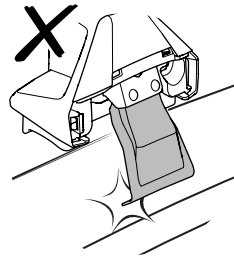
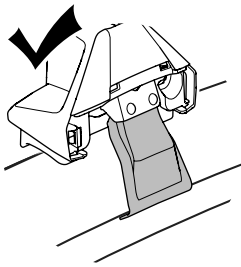
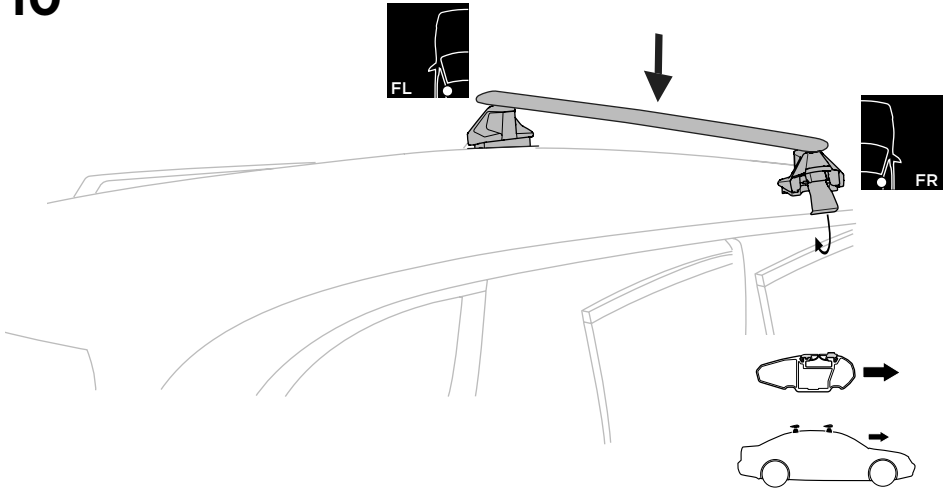

1

	Evo	Edge
	X	

	Evo	Edge
	Y	

	W	Z
--	---	---

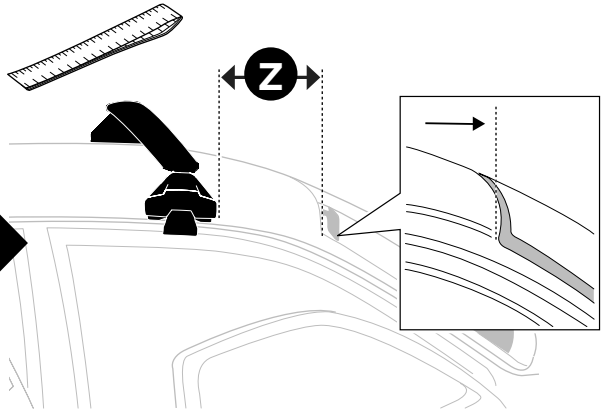

11

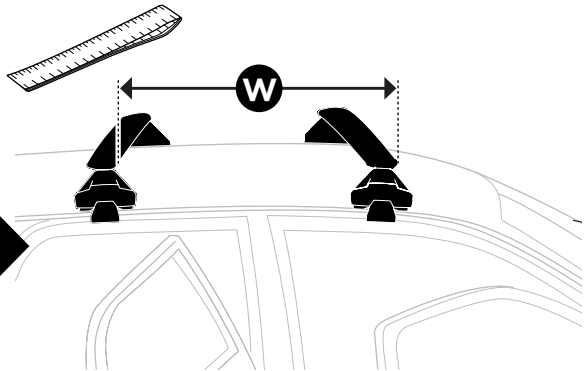
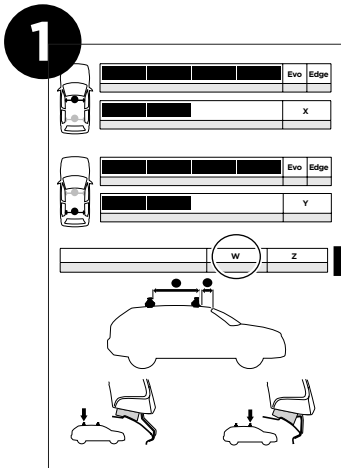
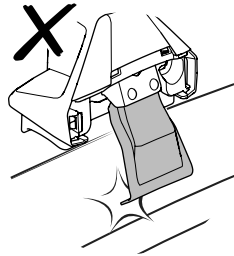
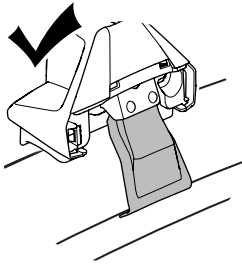
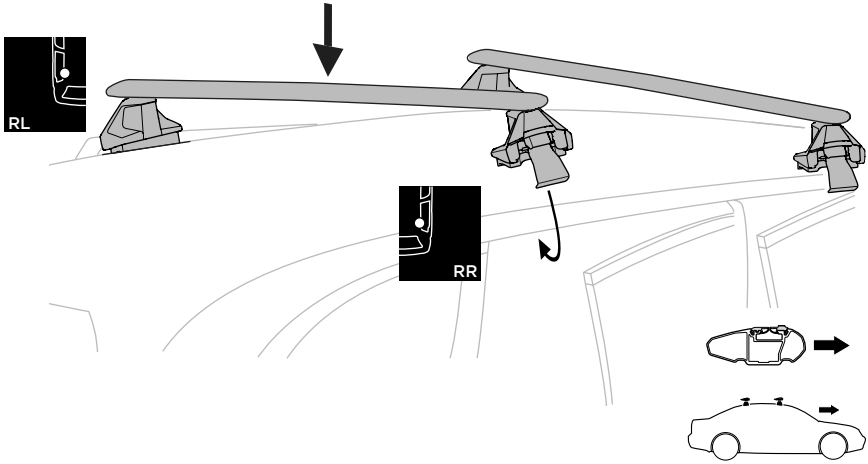

12

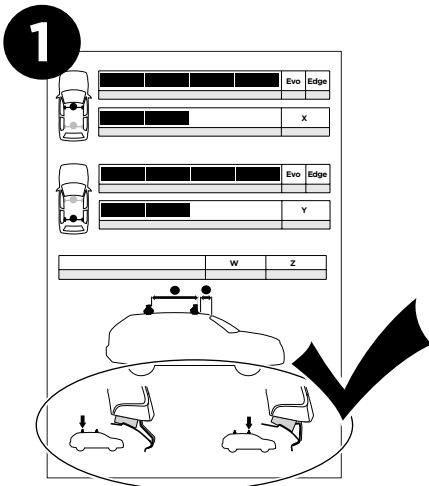
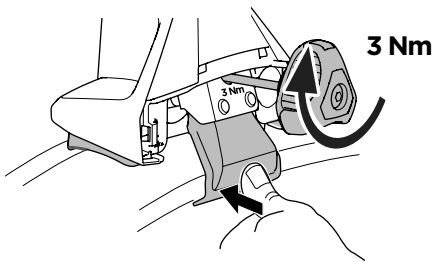
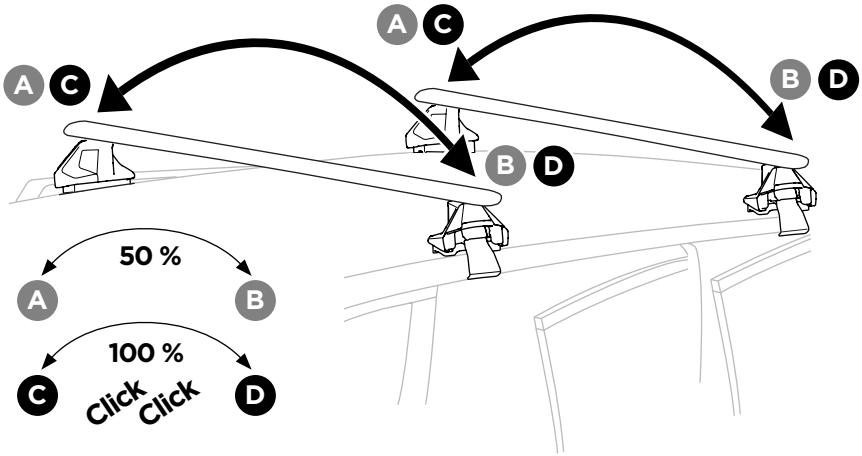

- EN** Tighten alternately
- DE** Die Schrauben abwechselnd anziehen
- FR** Serrer alternativement chaque côté
- NL** Afwisselend aan de linker- en de rechterkant aandraaien
- IT** Alternare il serraggio delle viti
- ES** Apretar alternativamente
- PT** Aperte alternadamente
- SV** Dra åt växelvis
- DK** Spænd skiftevis
- NO** Trekk til vekselvis
- FI** Kierrä vuorotellen
- ET** Pinguldage vaheldumisi
- LV** Pievelciet pamišus
- LT** Užsukinėkite pakaitomis
- PL** Śruby dokręcaj naprzemiennie
- RU** Затягивайте попеременно
- UK** Затягти по чергово
- BG** Затегнете последователно
- CS** Pokręťta багаžníka dokręcaj dokręcaj naprzemiennie.
- SK** Doťahujte striedavo
- SL** Privijajte izmenično
- HR/BiH** Naizmjenično zategnite
- RO** Strângeți alternativ
- HU** Egy mástól függetlenül szorítandó
- EL** Σφιγγετε εναλλάξ
- TR** Dönüşümlü sıkın

إحكام الربط بالتناوب **AR**
תזק לסירוקן **HE**

- ZH** 交替拧紧
- JA** 左右交互に締めつけてください
- KO** 번갈아 조이기
- TH** ขั้วในแบบสลับ

13

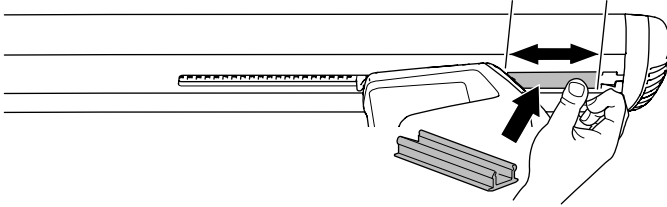
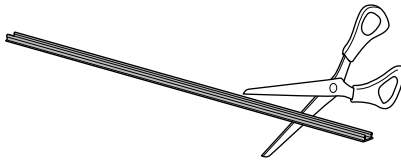

x4

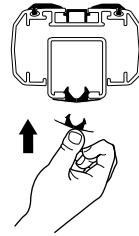
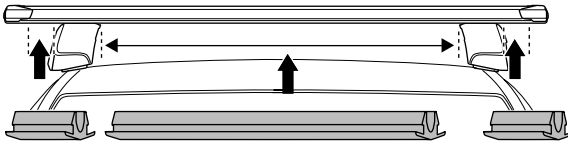
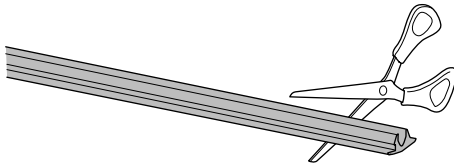

x2

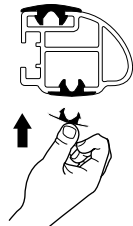
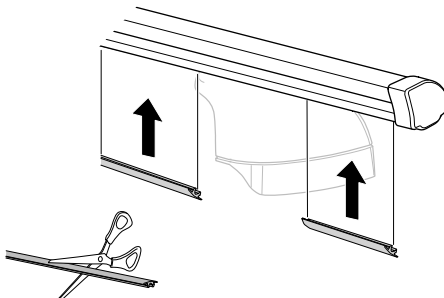
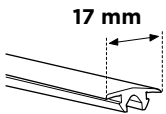

x2

14

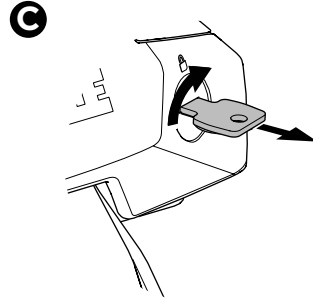
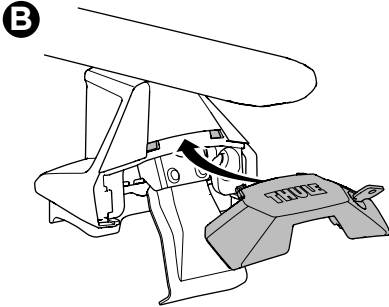
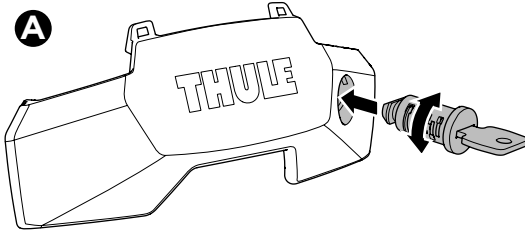

x4

15

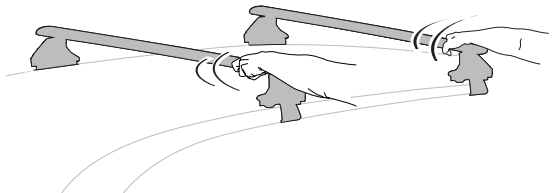
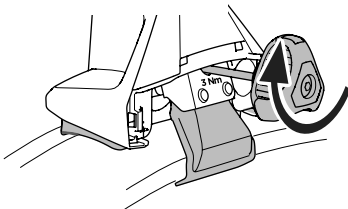
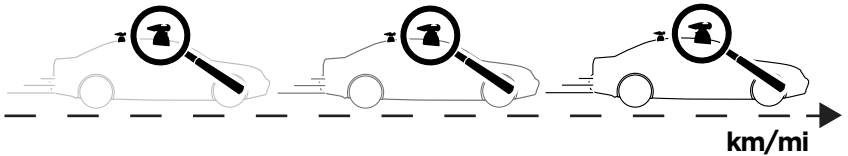
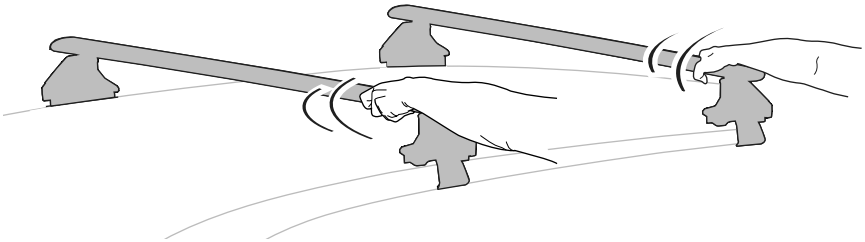

i

